

LED Headlight Conversion Kit - Direct Fit

999010

Product Information

Description	Direct Fit - 12/24V LED Bulb Kit 6000K - H10
Minimum Operating Temperature	-40 °C
Maximum Operating Temperature	130 °C
Connector or Wiring	H10



Product Dimensions

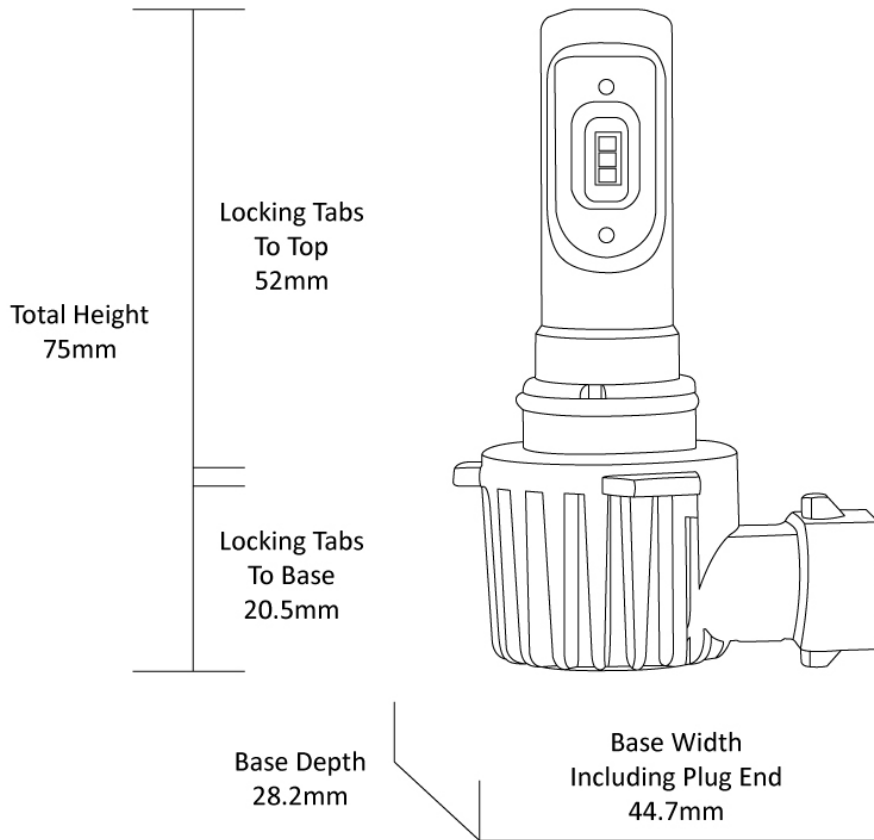

Electrical Specifications

Input Voltage	12-24V DC
Operating Voltage	12-24V DC

Photometric Specifications



Effective Lumen Output	1800 per bulb
Nominal LED Color Temperature	6000 K

Additional Specifications



IP Rating	IP65
Warranty	2 Year - Standard driving conditions: For normal day to day driving & recreational 4x4.
Pack Quantity	2