

LED Headlight Conversion Kit - Direct Fit

999006

Product Information

Description	Direct Fit - 12/24V LED Bulb Kit 6000K - HB4
Minimum Operating Temperature	-40 °C
Maximum Operating Temperature	130 °C
Connector or Wiring	HB4



Product Dimensions

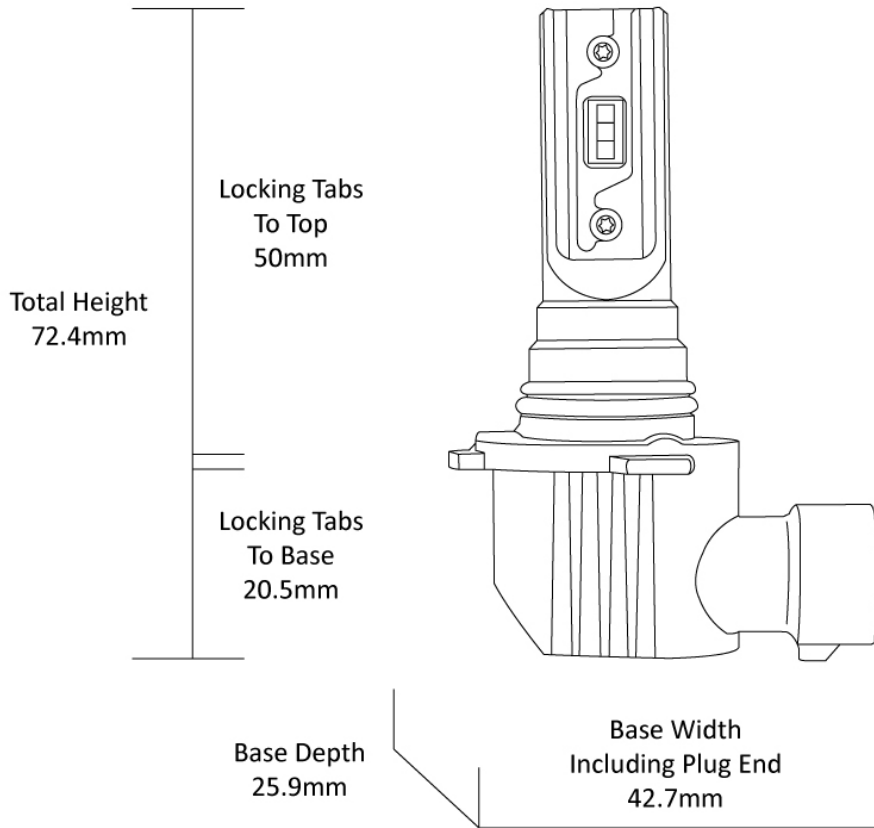

Electrical Specifications

Input Voltage	12-24V DC
Operating Voltage	12-24V DC

Photometric Specifications

Effective Lumen Output 1800 per bulb

Nominal LED Color Temperature 6000 K

Additional Specifications

IP Rating IP65

Warranty 2 Year - Standard driving conditions:
For normal day to day driving &
recreational 4x4.

Pack Quantity 2